

48V

**MT-J20-A**

RECESSED  
MAGNETIC TRACK

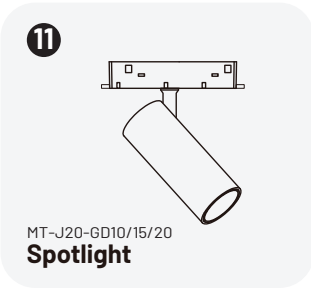

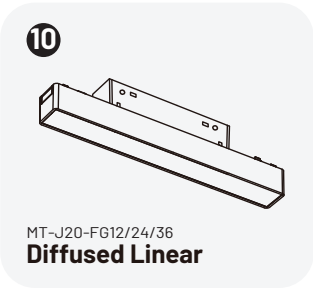
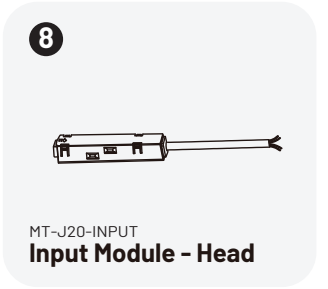
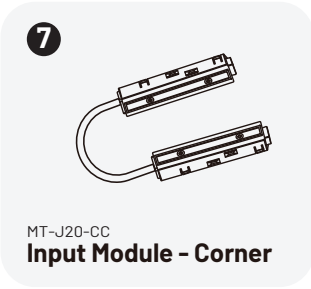
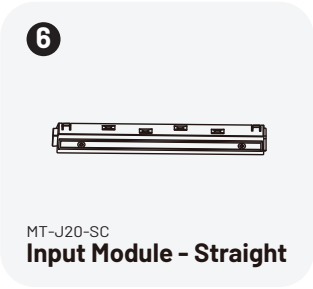
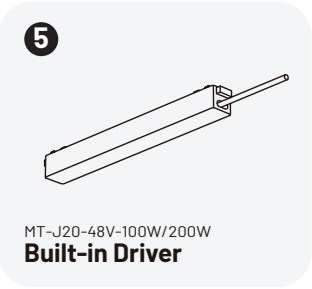
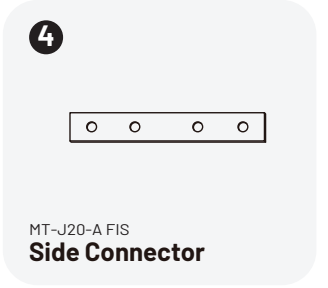
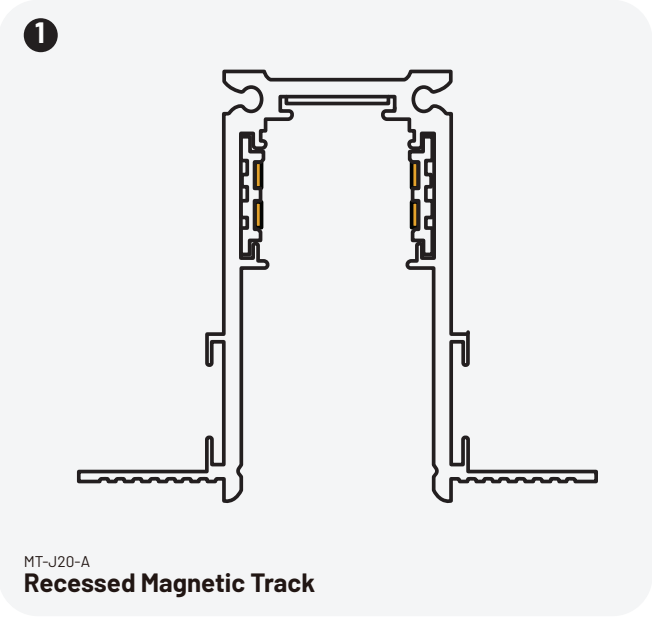
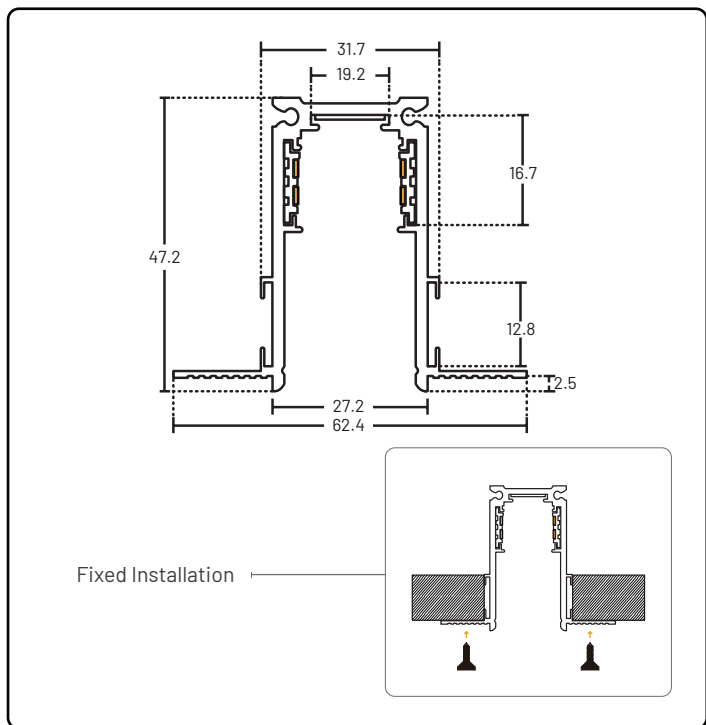

# MT-J20-A

## RECESSED MAGNETIC TRACK

- Recessed Track
- 2mm Aluminium
- 48V

### Colour



### Specifications

L2000mm x W27.2mm (62.4mm with wings) x H47.2mm

L3000mm x W27.2mm (62.4mm with wings) x H47.2mm

### Accessories

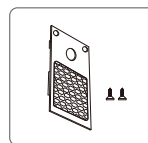

Track End Cap  
MT-J20-A-END

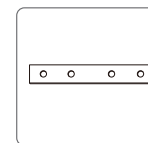

Connector  
MT-J20-A-FIS

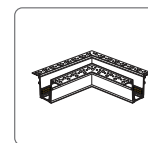

L-Shaped Track  
MT-J20-A-ZJ



Input Module - Straight  
MT-J20-SC

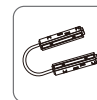

Input Module - Corner  
MT-J20-CC

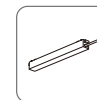

Built-in Driver For Magnetic  
MT-J20-48V-100W/200W

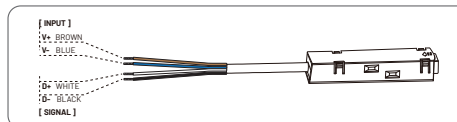

Input Module - Head  
MT-J20-INPUT

### Recessed Track

- **Neat Appearance:** The embedded design integrates the track and fixtures with the ceiling, creating a more streamlined and aesthetically pleasing look.
- **DIY Assembly:** The system is fully modular, allowing for interchangeable light fixtures to illuminate various spaces.
- **Variety of Styles:** Options include fixed and adjustable linear lighting as well as spotlights, suitable for both general and feature lighting.
- **Easy Maintenance:** Fixtures can be easily removed and reinstalled, making maintenance and replacement of lights more convenient.

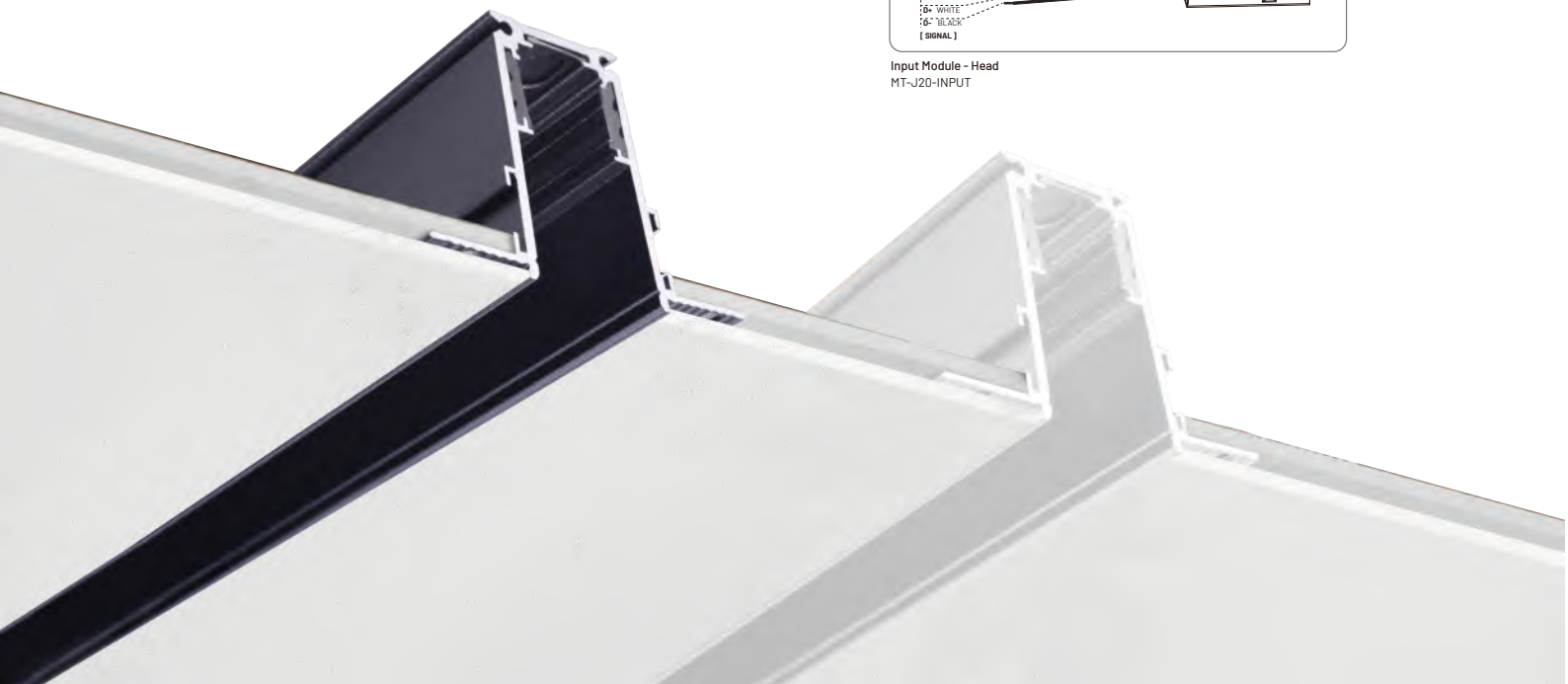

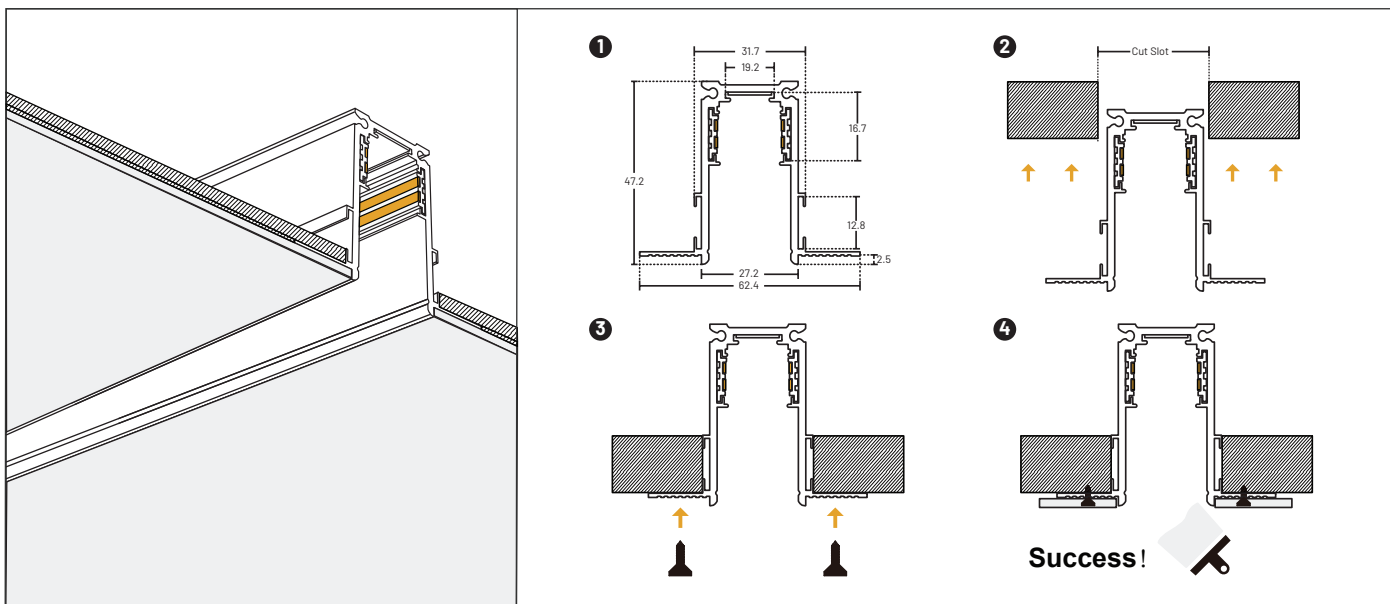

- 1** Check all dimensions of the plaster-in track prior to beginning installation. Do not cut gyprock without checking dimensions.
- 2** Check: Minimum Height Clearance above the Gyprock of 50mm is required to fit the track. Drill holes (for screws): approximately 32-35mm holes are recommended.
- 3** Insert the magnetic track into the pre-drilled holes and secure firmly with screws along the edges.
- 4** Once fixed, apply 2-3 coats of plaster over the surface until the gaps between the outer board and the track are completely covered. With this, the installation of the embedded track is complete.

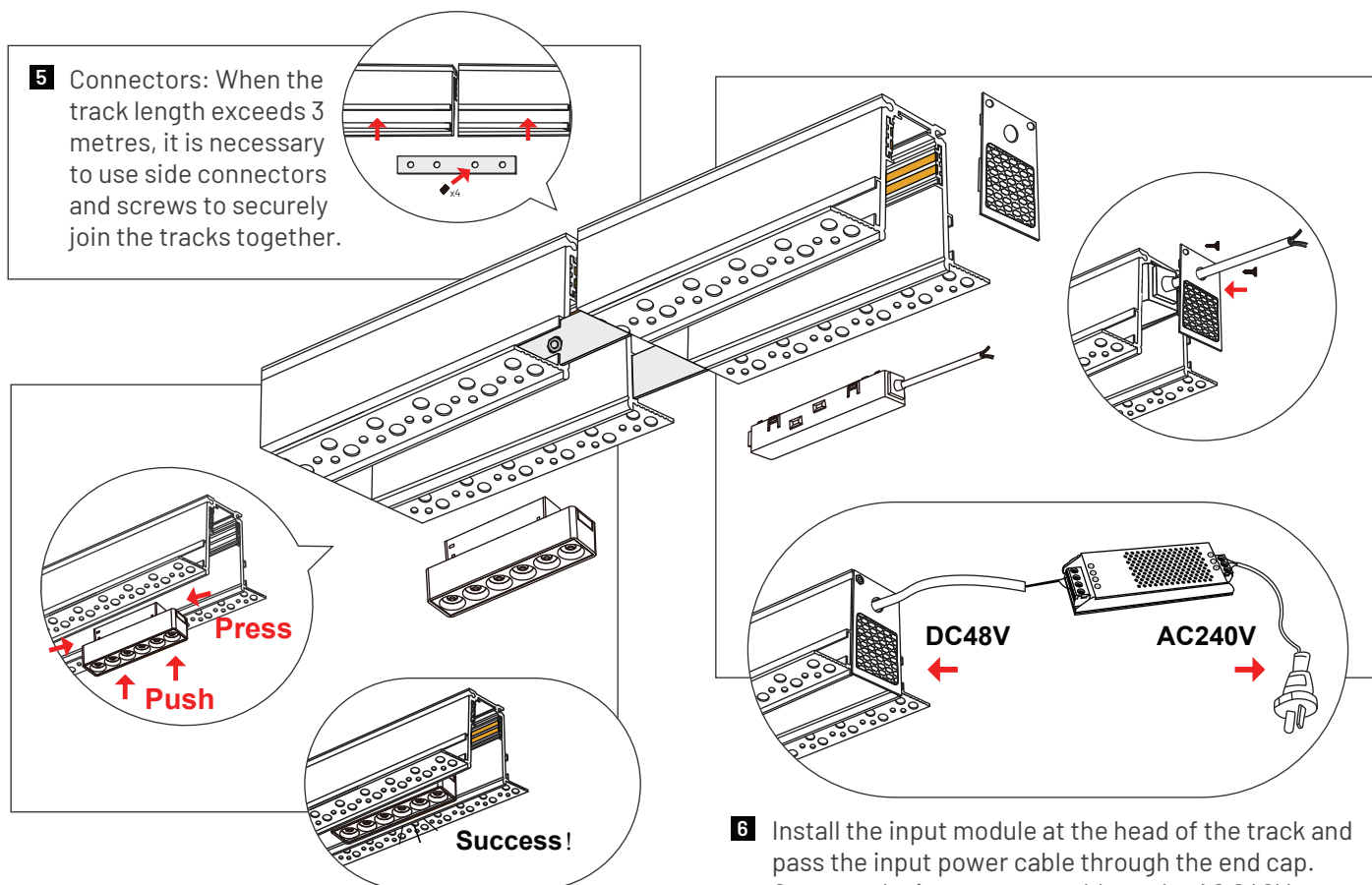

- 5** Connectors: When the track length exceeds 3 metres, it is necessary to use side connectors and screws to securely join the tracks together.
- 6** Install the input module at the head of the track and pass the input power cable through the end cap. Connect the input power cable to the AC 240V power supply. Ensure all connections are secure to guarantee the track lights operate correctly.
- 7** Remove protective cover if utilised, and install the light fixture into the magnetic track.

# Linear Grille Lamp

MT-J20-GS12/18/24

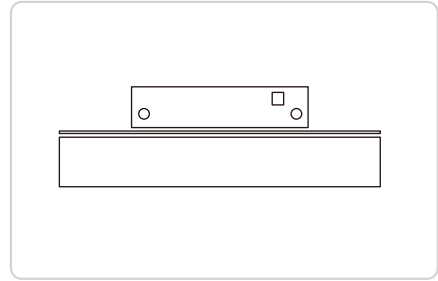
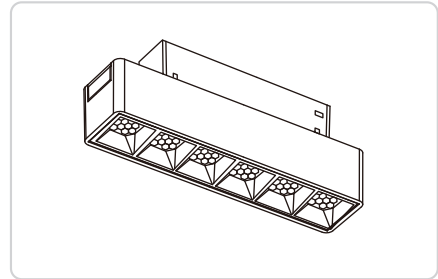

## Product Selection

Model:	MT-J20-GS12	MT-J20-GS18	MT-J20-GS24
Power:	12W	18W	24W
Size:	L220 x W22 x H25	L325 x W22 x H25	L430 x W22 x H25
Colour Temperature:	3000K	4000K	
Trim Colour:	Black	White	
Dimming Option:	Non-Dim	DALI	0-10V

\*Various lead times apply. Please contact our team for product enquiries.

# Diffused Linear

MT-J20-FG12/24/36

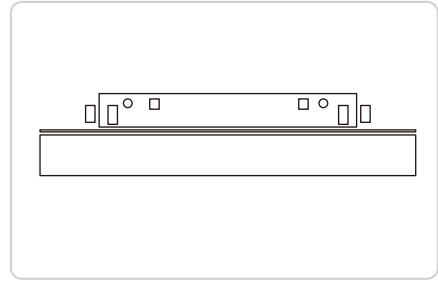
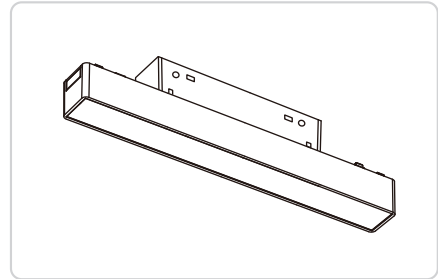
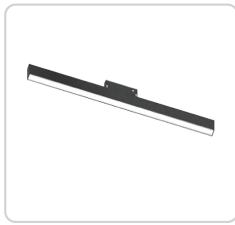
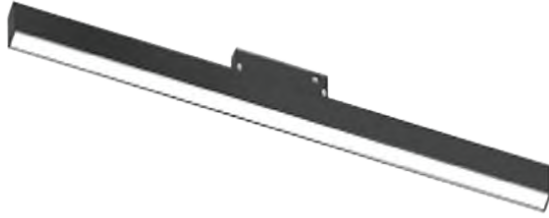

## Product Selection

Model:	MT-J20-FG12	MT-J20-FG24	MT-J20-FG36
Power:	12W	24W	36W
Size:	L302 x W31 x H26.5	L603 x W31 x H26.5	L903 x W31 x H26.5
Colour Temperature:	3000K	4000K	
Trim Colour:	Black	White	
Dimming Option:	Non-Dim	DALI	0-10V

\*Various lead times apply. Please contact our team for product enquiries.

# Track Spotlight

MT-J20-GD10/15/20

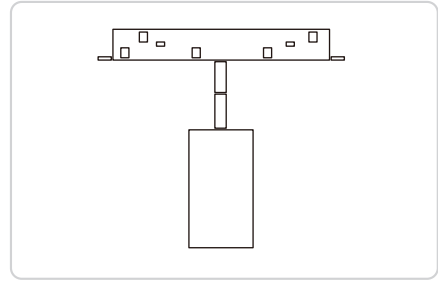
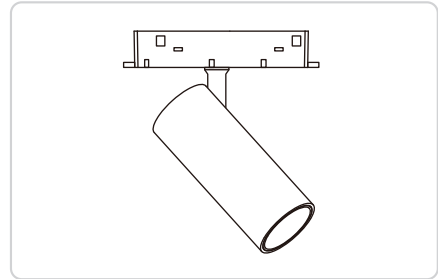

## Product Selection

Model:	MT-J20-GD10	MT-J20-GD15	MT-J20-GD20
Power:	10W	15W	20W
Size:	Ø45 MM x 100 MM	Ø55 MM x 115 MM	Ø55 MM x 120 MM
Colour Temperature:	3000K	4000K	
Trim Colour:	Black	White	
Dimming Option:	Non-Dim	DALI	0-10V

\*Various lead times apply. Please contact our team for product enquiries.

# Swivel Dot Linear

MT-J20-GSZD6/12

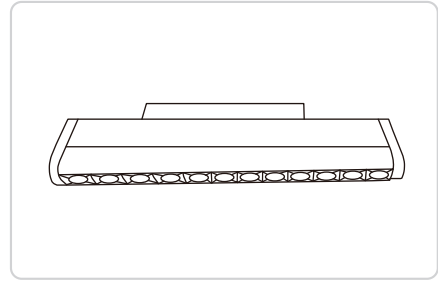
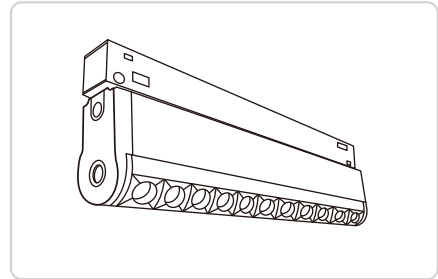

## Product Selection

Model:	MT-J20-GSZD6	MT-J20-GSZD12	
Power:	6W	12W	
Size:	L123 x W74.38 x H33.67	L231 x W74.38 x H33.67	
Colour Temperature:	3000K	4000K	
Trim Colour:	Black	White	
Dimming Option:	Non-Dim	DALI	0-10V

\*Various lead times apply. Please contact our team for product enquiries.



# Adjustable Dot Linear

MT-J20-ZD12

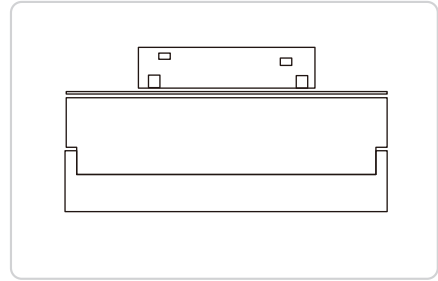
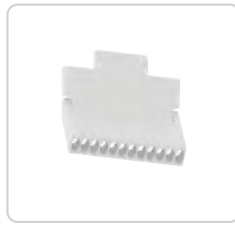
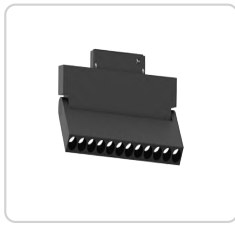
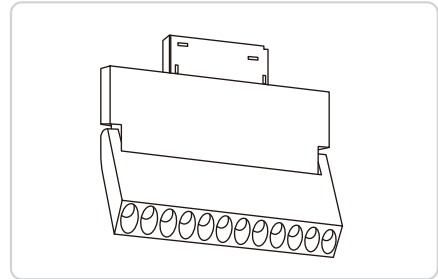

## Product Selection

Model:	MT-J20-ZD12		
Power:	12W		
Size:	L118 x W22 x H136		
Colour Temperature:	3000K	4000K	
Trim Colour:	Black	White	
Dimming Option:	Non-Dim	DALI	0-10V

\*Various lead times apply. Please contact our team for product enquiries.

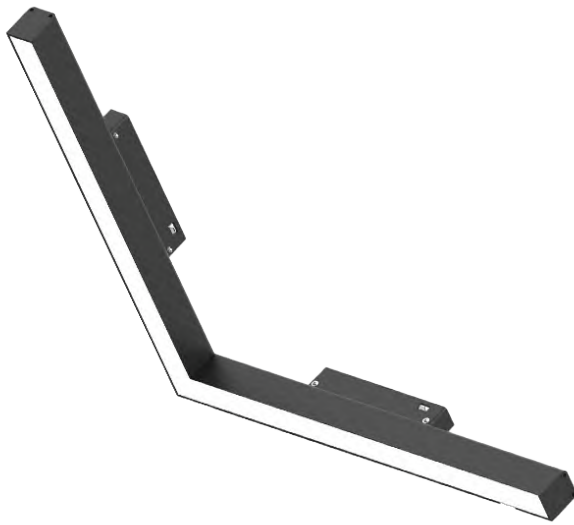

# L-Shape Diffused Linear

MT-J20-ZJ20

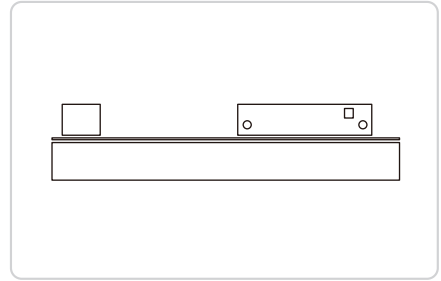
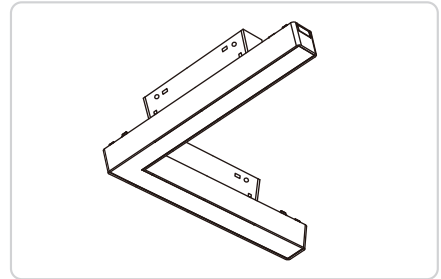
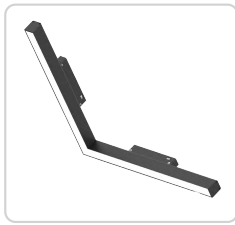

## Product Selection

Model:	MT-J20-ZJ20		
Power:	20W		
Size:	L300 x W200		
Colour Temperature:	3000K	4000K	
Trim Colour:	Black	White	
Dimming Option:	Non-Dim	DALI	0-10V

\*Various lead times apply. Please contact our team for product enquiries.