

48V

MT-J20-B

SUSPENDED / MOUNTED
MAGNETIC TRACK

1

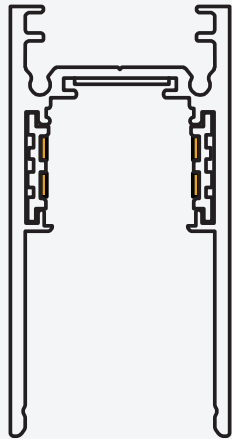

MT-J20-B
Recessed Magnetic Track

2

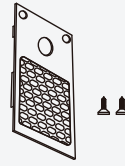

MT-J20-B END
Track End Cap

3



MT-J20-B FIS
Connector

4

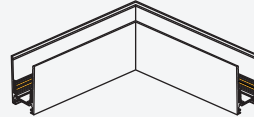

MT-J20-B-ZJ
L-Shaped Track

5

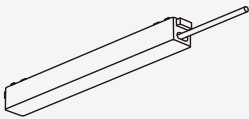

MT-J20-48V-100W/200W
Built-in Driver

6



MT-J20-SC
Input Module - Straight

7

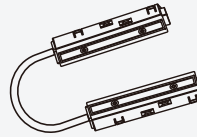

MT-J20-CC
Input Module - Corner

8



MT-J20-INPUT
Input Module - Head

9

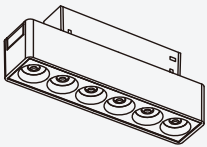

MT-J20-GS12/18/24
Linear Grille Lamp

10

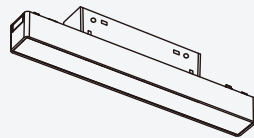

MT-J20-FG12/24/36
Diffused Linear

11

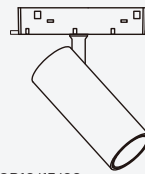

MT-J20-GD10/15/20
Spotlight

15

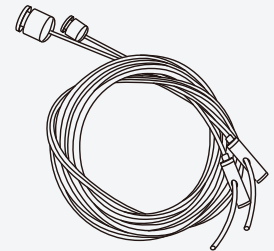

MT-SK
Suspended Kits

12

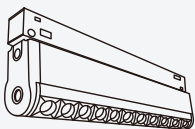

MT-J20-GSZD6/12
Swivel Dot Linear

13

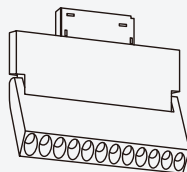

MT-J20-ZD12
Adjustable Dot Linear

14

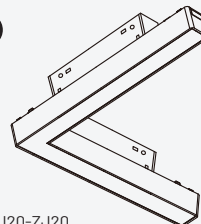

MT-J20-ZJ20
L-Shape Diffused Linear

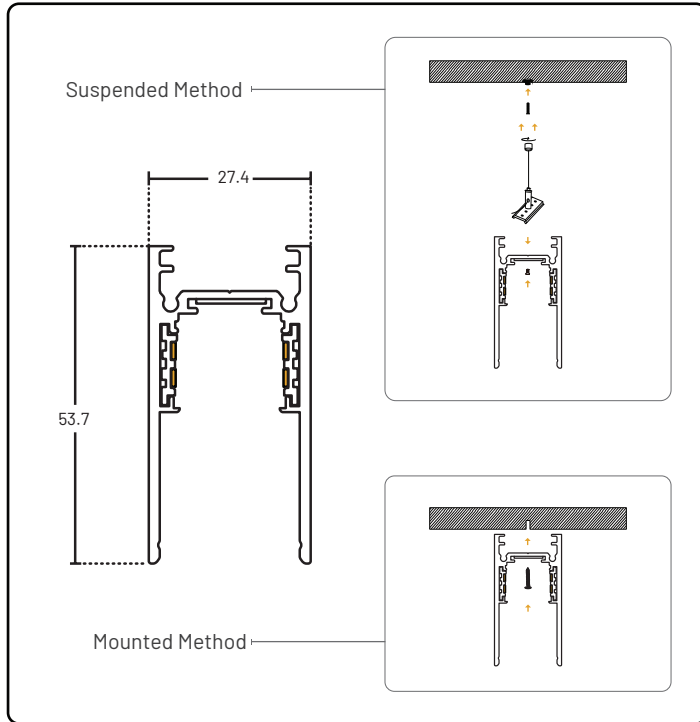

MT-J20-B

SUSPENDED/MOUNTED MAGNETIC TRACK

- Suspended / Mounted Track
- 2mm Aluminium
- 48V

Colour



Specifications

L2000mm x W27.4mm x H53.7mm

L3000mm x W27.4mm x H53.7mm

Accessories

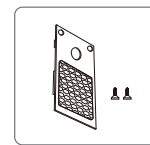

Track End Cap
MT-J20-B END

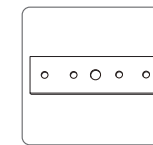

Connector
MT-J20-B FIS

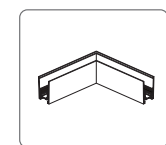

L-Shaped Track
MT-J20-B-ZJ



Input Module - Straight
MT-J20-SC

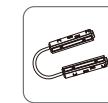

Input Module - Corner
MT-J20-CC

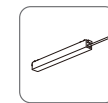

Built-in Driver For Magnetic
MT-J20-48V-100W/200W

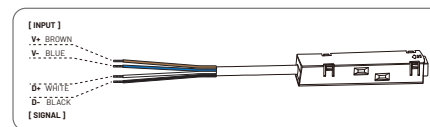

Input Module - Head
MT-J20-INPUT



Suspended Kits
MT-SK

SUSPENDED/MOUNTED

- **Two Installation Methods:** This track offers both suspension and surface mounting options to meet diverse needs.
- **DIY Assembly:** The system is fully modular, allowing for interchangeable light fixtures to illuminate various spaces.
- **Easy Maintenance:** Fixtures can be easily removed and reinstalled, making maintenance and replacement of lights more convenient.



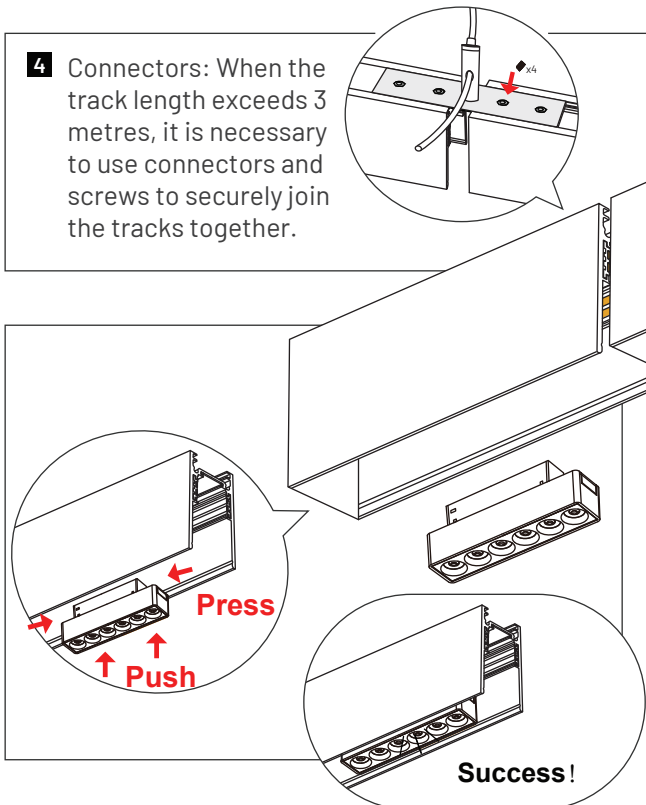
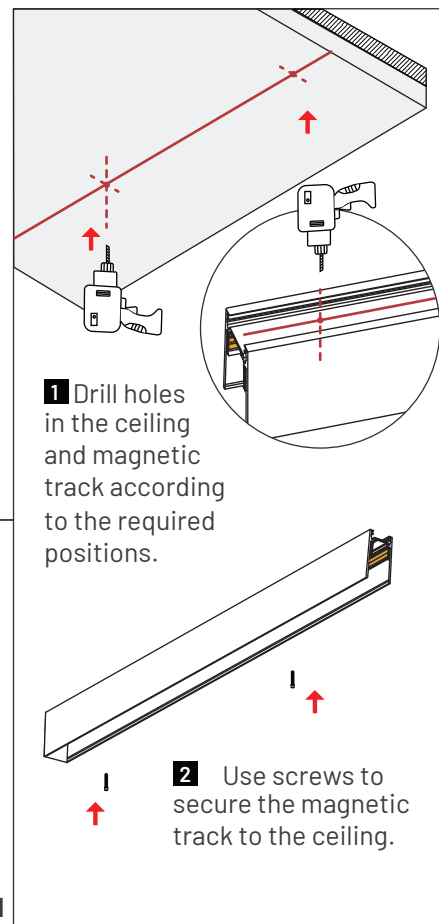
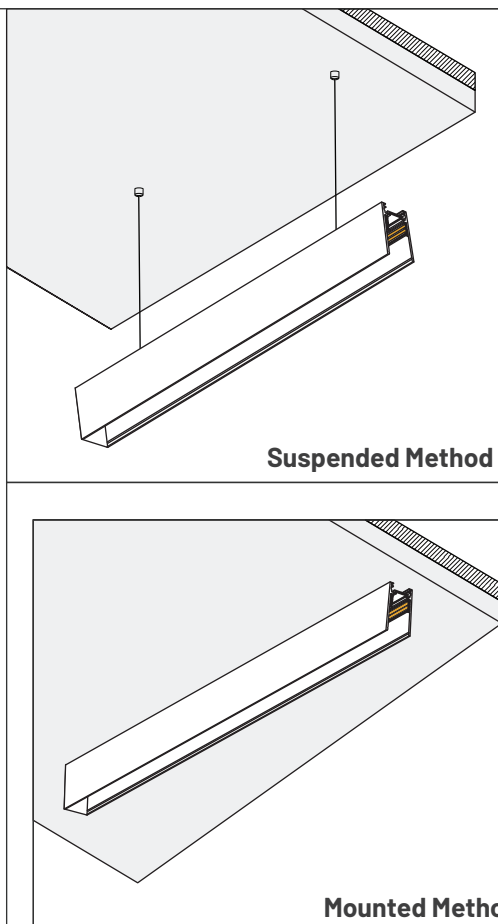
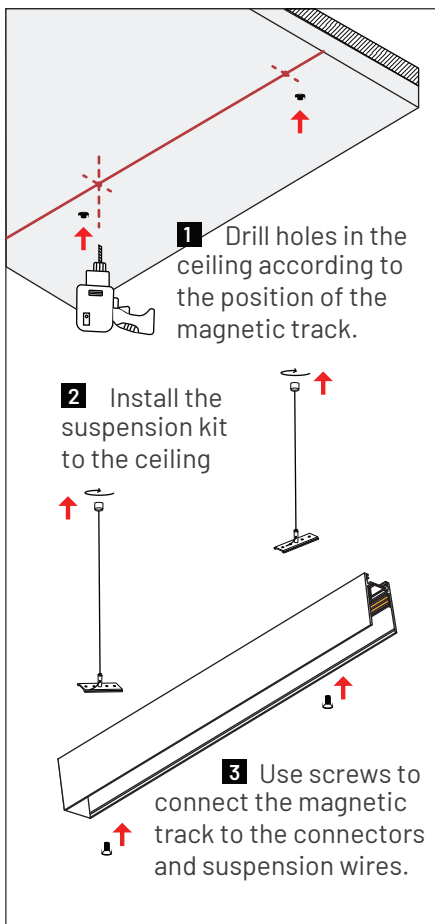

6 Remove protective cover if utilised, and install the light fixture into the magnetic track.

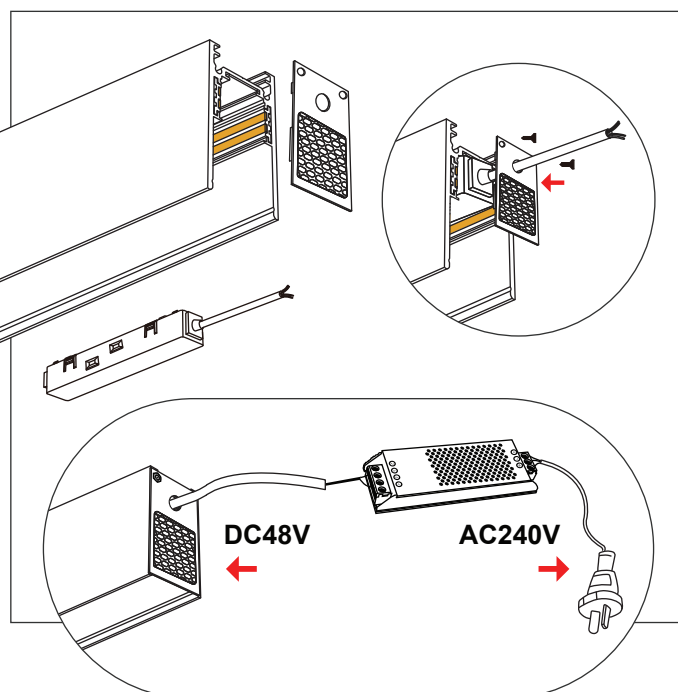

5 Install the input module at the head of the track and pass the input power cable through the end cap. Connect the input power cable to the AC 240V power supply. Ensure all connections are secure to guarantee the track lights operate correctly.

Linear Grille Lamp

MT-J20-GS12/18/24

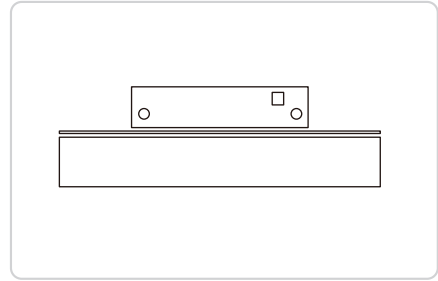
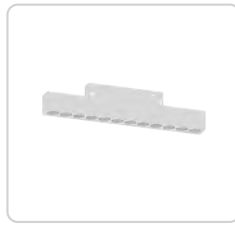
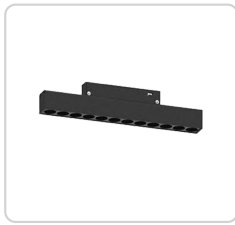
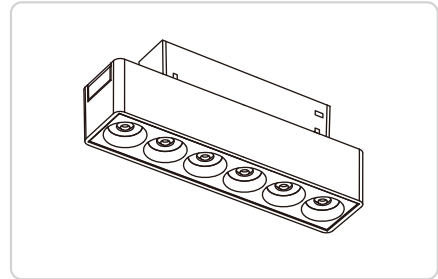

Product Selection

Model:	MT-J20-GS12	MT-J20-GS18	MT-J20-GS24
Power:	12W	18W	24W
Size:	L220 x W22 x H25	L325 x W22 x H25	L430 x W22 x H25
Colour Temperature:	3000K	4000K	
Trim Colour:	Black	White	
Dimming Option:	Non-Dim	DALI	0-10V

*Various lead times apply. Please contact our team for product enquiries.

Diffused Linear

MT-J20-FG12/24/36

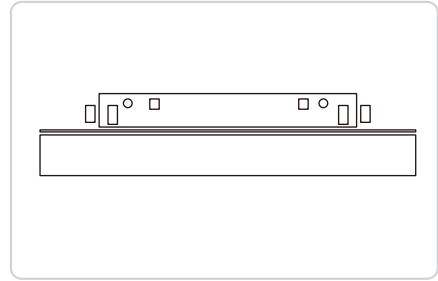
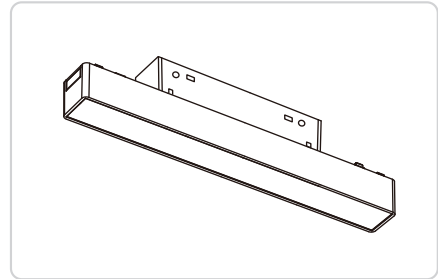
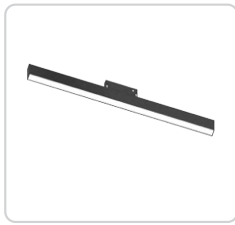

Product Selection

Model:	MT-J20-FG12	MT-J20-FG24	MT-J20-FG36
Power:	12W	24W	36W
Size:	L302 x W31 x H26.5	L603 x W31 x H26.5	L903 x W31 x H26.5
Colour Temperature:	3000K	4000K	
Trim Colour:	Black	White	
Dimming Option:	Non-Dim	DALI	0-10V

*Various lead times apply. Please contact our team for product enquiries.

Track Spotlight

MT-J20-GD10/15/20

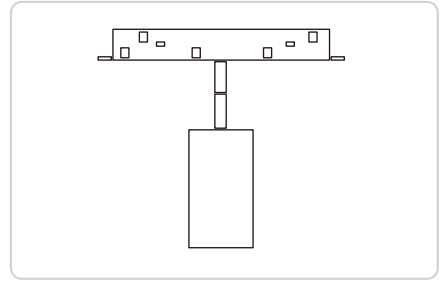
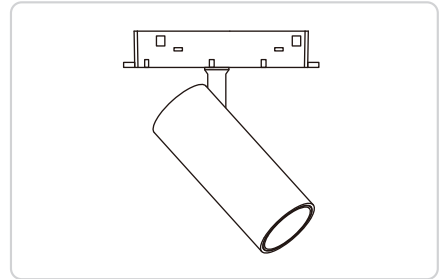

Product Selection

Model:	MT-J20-GD10	MT-J20-GD15	MT-J20-GD20
Power:	10W	15W	20W
Size:	Ø45 MM x 100 MM	Ø55 MM x 115 MM	Ø55 MM x 120 MM
Colour Temperature:	3000K	4000K	
Trim Colour:	Black	White	
Dimming Option:	Non-Dim	DALI	0-10V

*Various lead times apply. Please contact our team for product enquiries.

Swivel Dot Linear

MT-J20-GSZD6/12

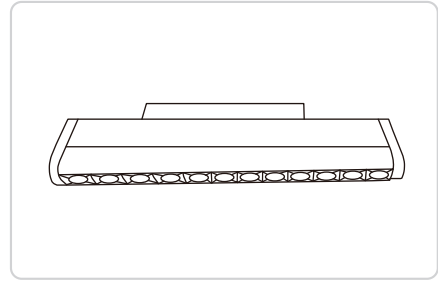
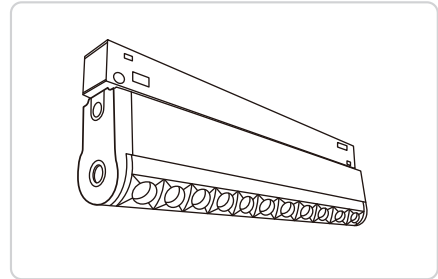

Product Selection

Model:	MT-J20-GSZD6	MT-J20-GSZD12	
Power:	6W	12W	
Size:	L123 x W74.38 x H33.67	L231 x W74.38 x H33.67	
Colour Temperature:	3000K	4000K	
Trim Colour:	Black	White	
Dimming Option:	Non-Dim	DALI	0-10V

*Various lead times apply. Please contact our team for product enquiries.

Adjustable Dot Linear

MT-J20-ZD12

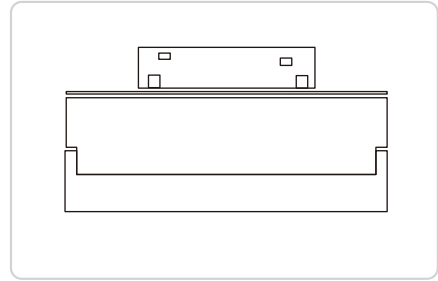
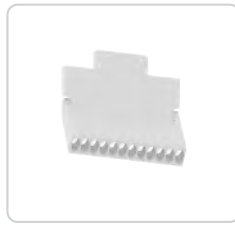
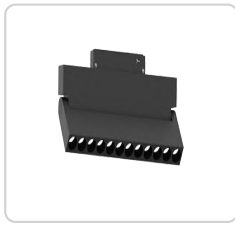
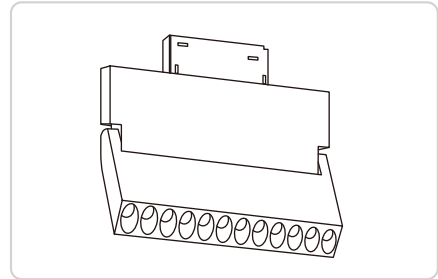

Product Selection

Model:	MT-J20-ZD12		
Power:	12W		
Size:	L118 x W22 x H136		
Colour Temperature:	3000K	4000K	
Trim Colour:	Black	White	
Dimming Option:	Non-Dim	DALI	0-10V

*Various lead times apply. Please contact our team for product enquiries.

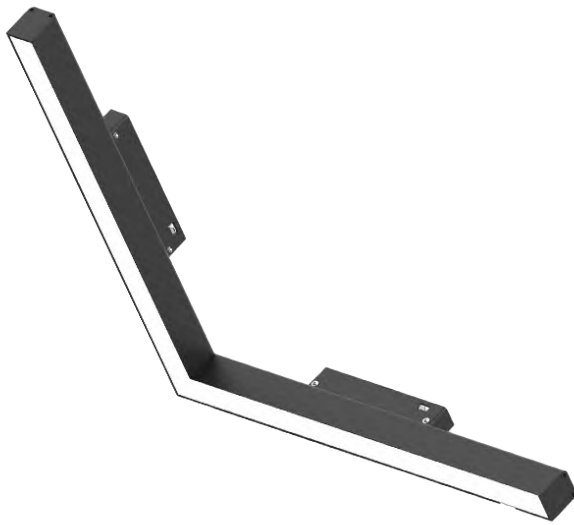

L-Shape Diffused Linear

MT-J20-ZJ20

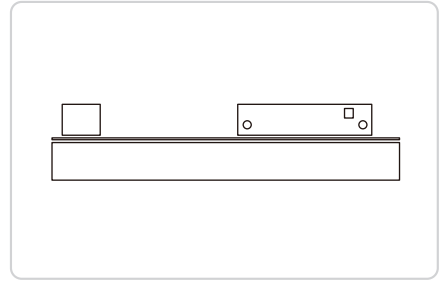
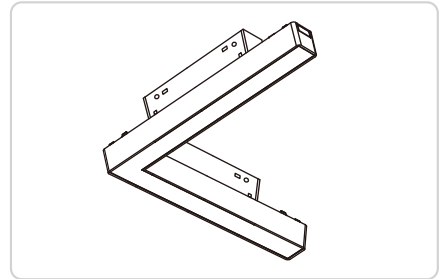
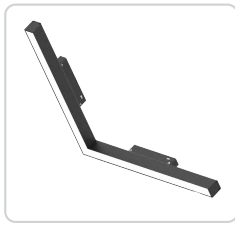

Product Selection

Model:	MT-J20-ZJ20		
Power:	20W		
Size:	L300 x W200		
Colour Temperature:	3000K	4000K	
Trim Colour:	Black	White	
Dimming Option:	Non-Dim	DALI	0-10V

*Various lead times apply. Please contact our team for product enquiries.